

2/2-Wege Coaxialventil 2/2-way coaxial valve

Baureihe 283 Type 283

fremdgesteuert
externally controlled

Schaltfunktion A: NC (stromlos geschlossen)
function A: NC (normally closed)

Schaltfunktion B: NO (stromlos offen)
function B: NO (normally open)

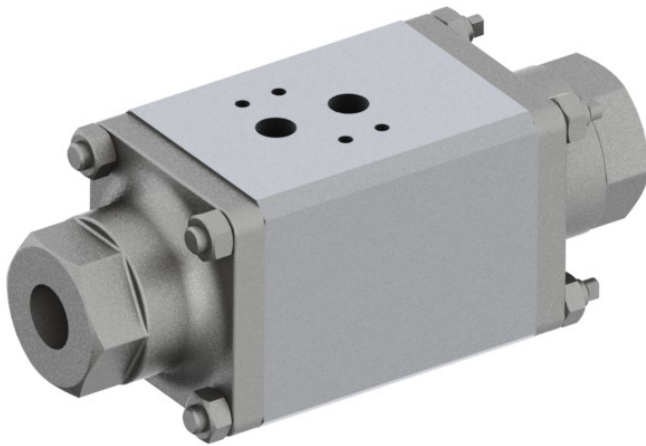
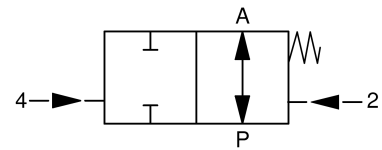
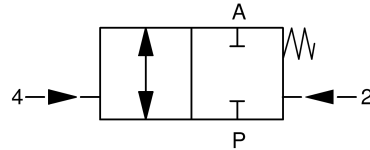

Nennweite	DN 15	diameter	DN 15
Druckbereich	0 – max. 200bar Gegendruckdicht bis 16bar	pressure range	0 – max. 200bar backpressure leakproof up to max. 16bar
Gehäusewerkstoff	Messing, 1.4305, 1.4571	body material	brass, AISI 303, AISI 316
Dichtwerkstoff	statisch: FKM dynamisch: PTFE Sitzdichtung: PTFE	seal material	static: FKM dynamic: PTFE seat seal: PTFE
Temperatur	Medium: -10 bis +100°C Umgebung: -10 bis +50°C	temperature	media: -10 up to +100°C ambient: -10 up to +50°C
Anschluss	G3/8 – G3/4	connection	G3/8 – G3/4
Durchflussrichtung	P → A max. 200bar A → P max. 16bar	flow direction	P → A max. 200bar A → P max. 16bar
Antriebsteil	doppelt wirkender Kolben mit Rückstellfeder	actuating part	double acting piston with return spring
Steuerdruck	3 – 8bar Anschlüsse 2+4 (G1/4) Schnittstelle nach NAMUR eine vorgeschaltete Wartungseinheit verlängert die Lebensdauer der Ventile	control pressure	3 – 8bar connections 2+4 (G1/4) port according to NAMUR an upstreamed service unit extends the lifetime of the valves
Schaltzeiten	Öffnen / Schließen 50 – 1000ms abhängig vom Steuerdruck, Pilotventil (Option) und Abluftdrosseln (Option)	switching time	opening / closing 50 – 1000ms depending on operating pressure, pilot valve (option) and exhaust air throttle (option)
Einbaulage	beliebig	mounting	in any position

2/2-Wege Coaxialventil
2/2-way coaxial valve
Baureihe 283
Type 283

DN [mm]	Druck pressure range [bar]	Anschluss connection	K _v -Wert flow rate [m ³ /h]	Gewicht weight [kg]
15	0 – 200	G3/8, G1/2, G3/4	7,2	3,2

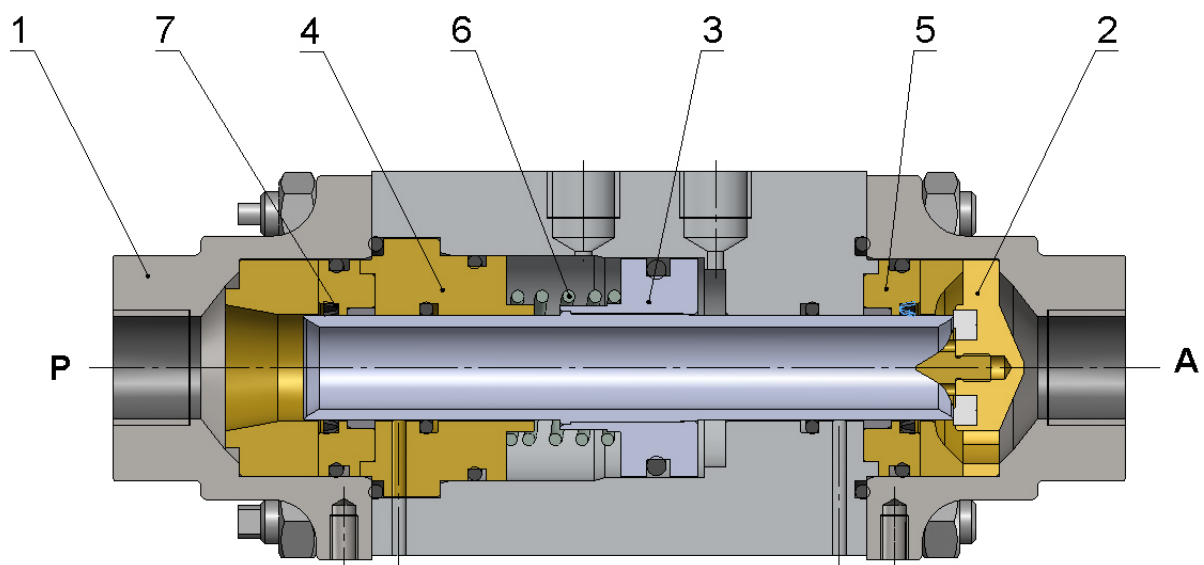
Schnittzeichnung
sectional drawing

Pos. pos.	Menge quantity	Benennung	description
1	2	Anschlussstück	adapter fitting
2	1	Ventilsitz	valve seat
3	1	Kolben / Steuerrohr	piston / control tube
4	1	Betätigungsscheibe	actuating plate
5	2	Führungsscheibe	guiding disk
6	1	Feder	spring
7	2	PTFE-Stangendichtung	PTFE-rod seal

2/2-Wege Coaxialventil
2/2-way coaxial valve

Baureihe 283
Type 283

Maßzeichnung
dimension drawing

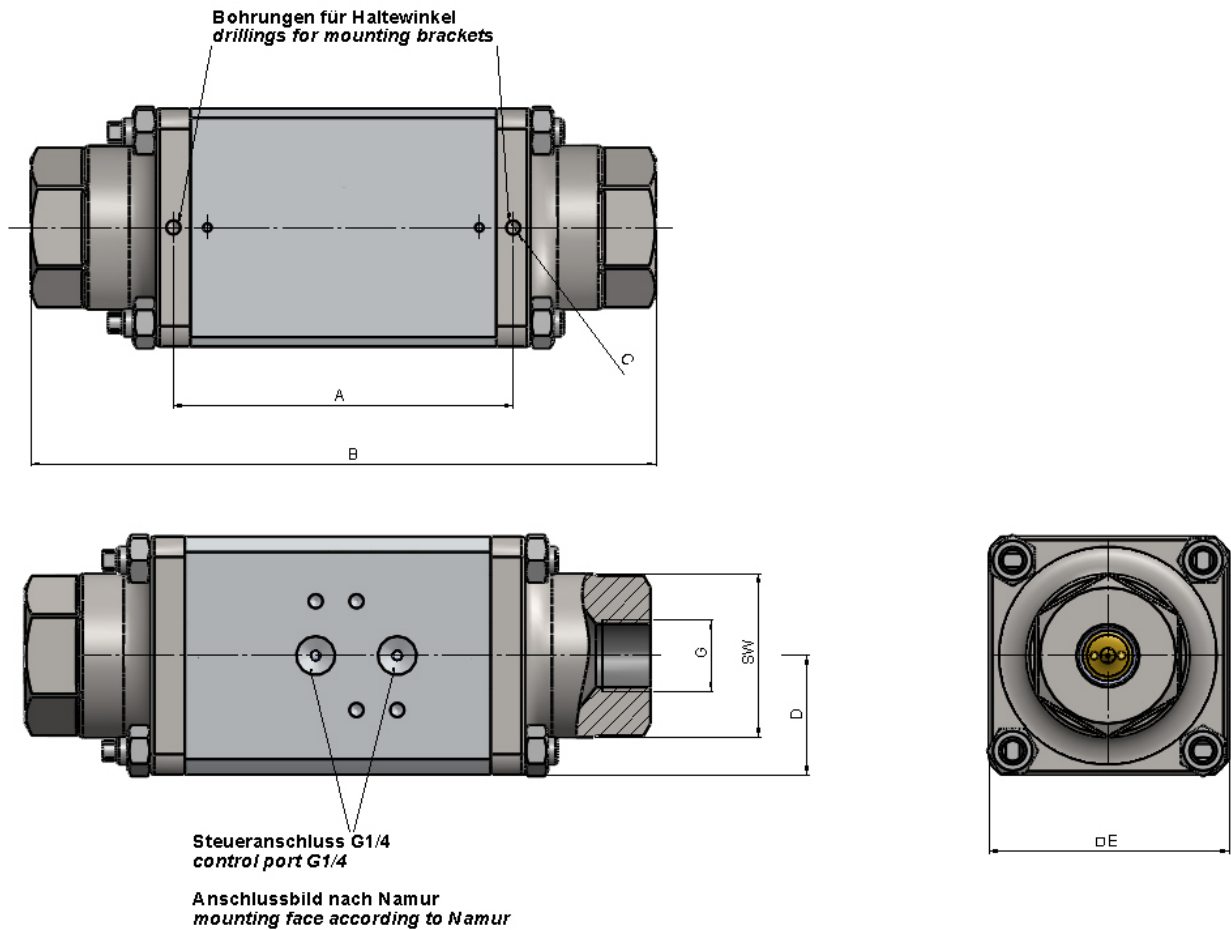

DN [mm]	G	SW	A [mm]	B [mm]	C	D [mm]	E [mm]
15	3/8, 1/2, 3/4	50	100	184	M5	35	70

2/2-Wege Coaxialventil 2/2-way coaxial valve



Baureihe 283 Type 283

Typenschlüssel type code

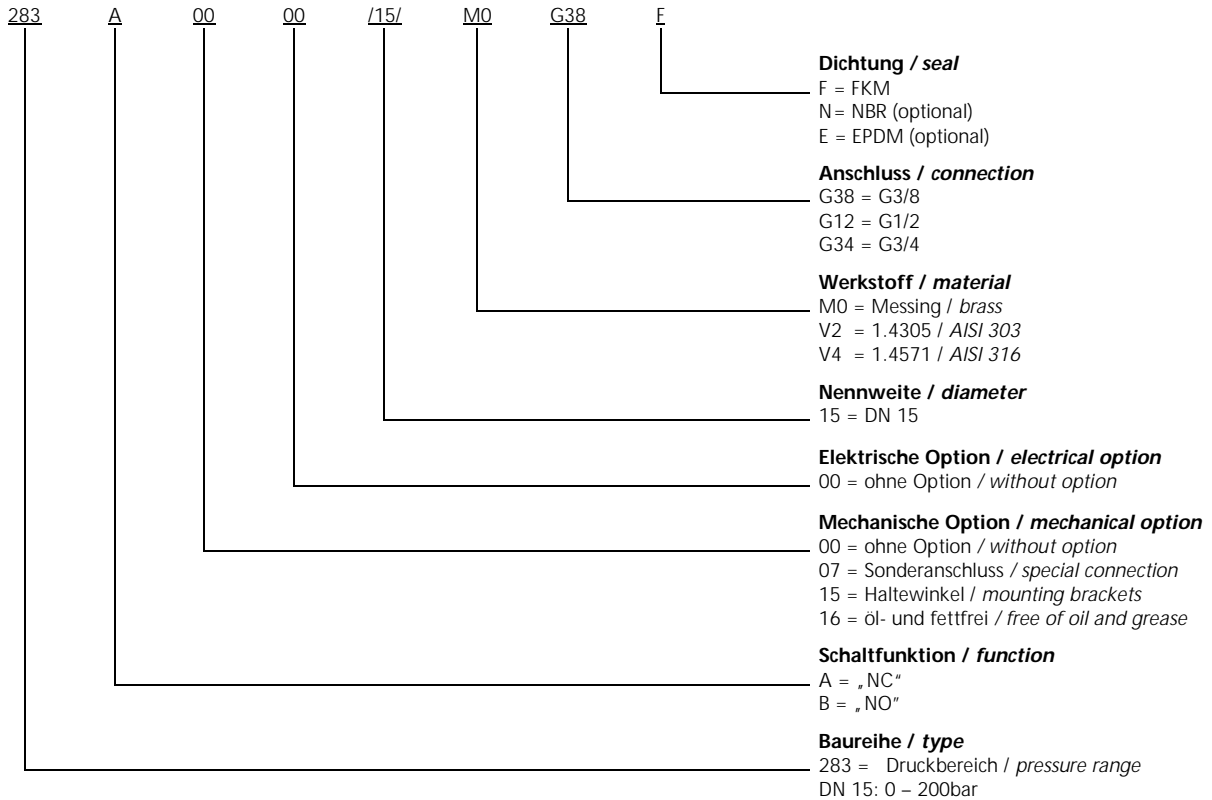

Die Typenbezeichnung setzt sich zusammen aus:
structure of the order specification:

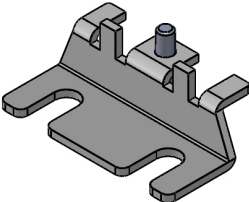
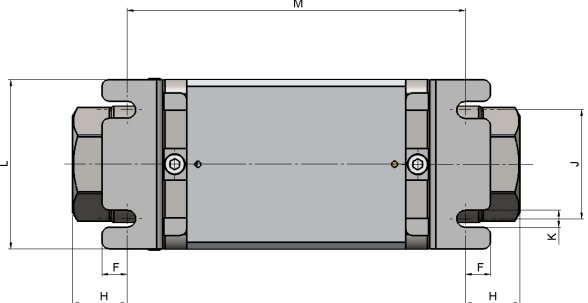

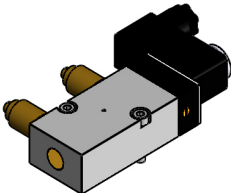
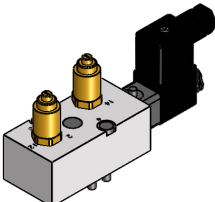
2/2-Wege Coaxialventil
2/2-way coaxial valve
Baureihe 283
Type 283
Zubehör
accessories

	<p>Haltewinkel <i>mounting brackets</i></p> <p>mechanische Option = 15 <i>mechanical option = 15</i></p>	 <table border="1" data-bbox="820 779 1430 882"> <thead> <tr> <th>DN</th> <th>F</th> <th>H</th> <th>J</th> <th>K</th> <th>L</th> <th>M</th> </tr> <tr> <th>[mm]</th> <th>[mm]</th> <th>[mm]</th> <th>[mm]</th> <th>[mm]</th> <th>[mm]</th> <th>[mm]</th> </tr> </thead> <tbody> <tr> <td>15</td> <td>10,5</td> <td>22</td> <td>45</td> <td>7</td> <td>70</td> <td>139</td> </tr> </tbody> </table>	DN	F	H	J	K	L	M	[mm]	[mm]	[mm]	[mm]	[mm]	[mm]	[mm]	15	10,5	22	45	7	70	139
DN	F	H	J	K	L	M																	
[mm]	[mm]	[mm]	[mm]	[mm]	[mm]	[mm]																	
15	10,5	22	45	7	70	139																	
	<p>Abluftdrossel <i>exhaust air throttle</i></p> <p>G1/8 G1/4</p>																						
	<p>Schalldämpfer Sinterbronze <i>silencer of sinter bronze casting</i></p> <p>G1/8 G1/4</p>																						
	<p>5/2-Wege Pilotventil (NAMUR) zum Anflanschen Anschlüsse seitlich <i>5/2-way pilot valve (NAMUR) to flange connections laterally</i></p> <p>24V DC 230V 50Hz</p>																						
	<p>5/2-Wege Pilotventil (NAMUR) zum Anflanschen Anschlüsse oben <i>5/2-way pilot valve (NAMUR) to flange connections above</i></p> <p>24V DC 230V 50Hz</p>																						

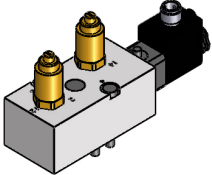
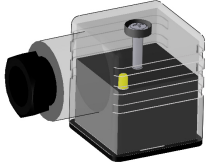
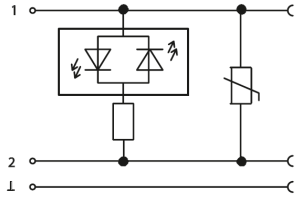
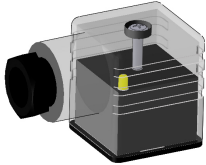
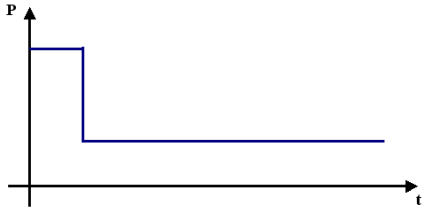
2/2-Wege Coaxialventil
2/2-way coaxial valve
Baureihe 283
Type 283

	<p>5/2-Wege Pilotventil (NAMUR) zum Anflanschen Anschlüsse oben Magnet M12x1 <i>5/2-way pilot valve (NAMUR) to flange connections above solenoid M12 x 1</i></p> <p>24V DC 230V 50Hz</p>	
	<p>Gerätesteckdose mit LED <i>plug with LED</i></p> <p>elektrische Option = 20 <i>electrical option = 20</i></p>	
	<p>Gerätesteckdose mit Leistungsabsenkung 24V DC Bauform A <i>plug with power reduction form A</i></p> <p>elektrische Option = 07 <i>electrical option = 07</i></p>	
	<p>Sonderschutzart <i>explosion proof</i></p> <p>II 2G Ex m II T4 II 3D IP65 T130°C</p> <p>elektrische Option = 13 <i>electrical option = 13</i></p>	

Weitere Optionen und Zubehör stimmen wir gerne auf Ihre Anforderungen ab.
We gladly coordinate further options and accessories according to your requirements.